

6100

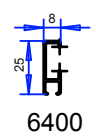

6400

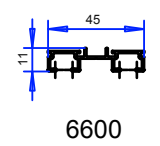

6600

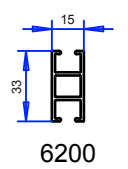

6200

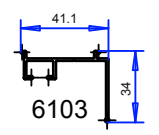

6103

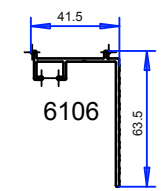

6106

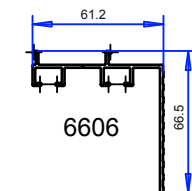

6606

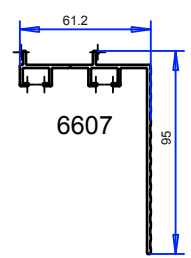

6607

Mitoitus seinäkannakkeen nro.1 kanssa

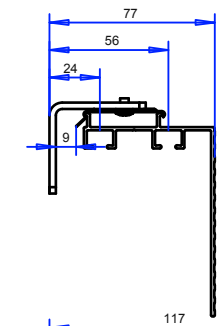
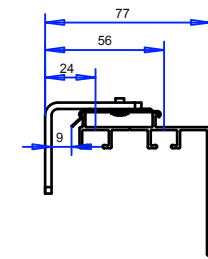
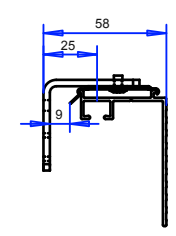
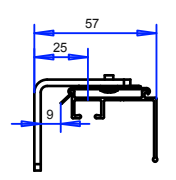
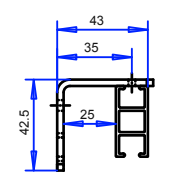
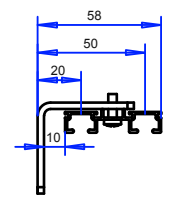
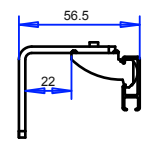
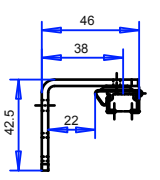

Mitoitus seinäkannakkeen nro.2 kanssa

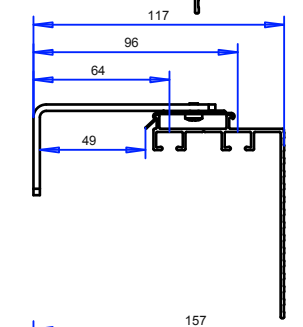
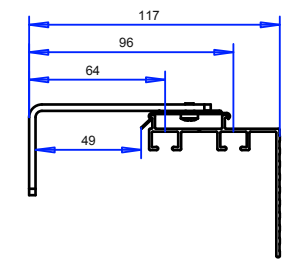
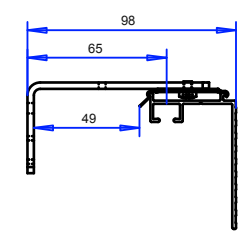
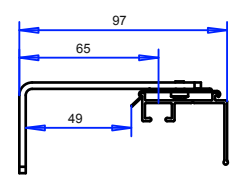
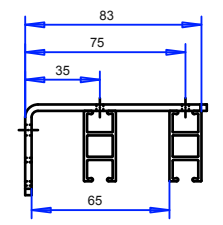
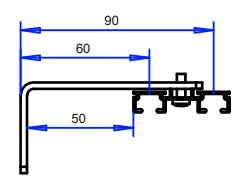
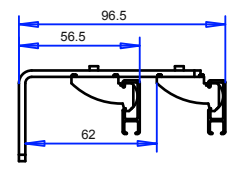
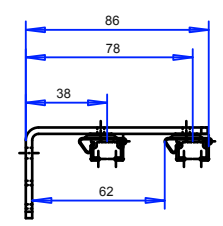

Mitoitus seinäkannakkeen nro.3 kanssa

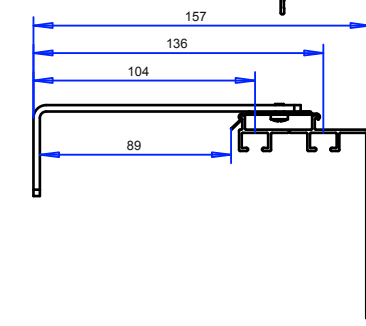
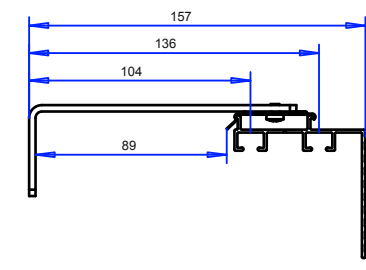
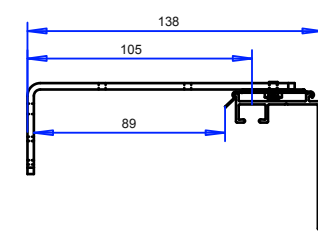
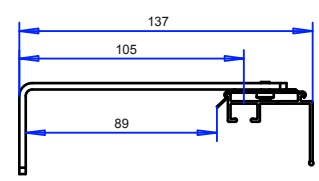
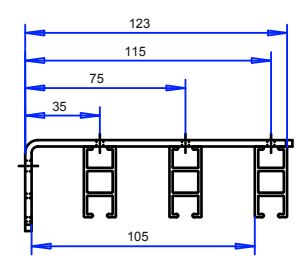
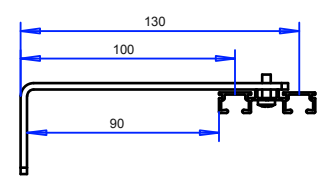
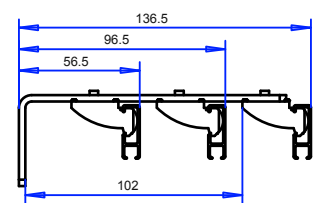
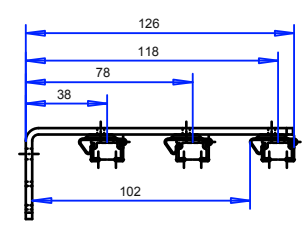

Osa	Piirustusnumero Tavaratunnus	Osan tai kokoonpanoryhmän kuvaus	Standardi tai luettelo	Muoto, malli Lajimerkki	Määrä	Laatu	Kpl
Yleistoleranssit		Mittakaava		Tuote	Verhokiskojärjestelmät		
Massa	kg	1:2.5		Liitty			
Suunn	2009-04-14 VS			Projekti			
Tark.				Apukuvat			
				FP-TUOTTEET OY	Ent.	Uusi	
					30242		

Merkki	Muutos	Pvm	Muutt.	Hyv.	Hyv.
--------	--------	-----	--------	------	------